

CANTY

PROCESS TECHNOLOGY

PROCESS MICROSCOPE CAMERA SYSTEMS



PARTICLE SIZING

The Cauty Process Microscope Camera is a high speed system that captures and displays live video images for blur-free, flicker-free pictures. The Process Microscope Camera features a unique lens that views particles as small as 1 micron, with optional zoom controls to widen the view angle to 1000 microns (additional size ranges through 10 in. are available - consult factory). Process Microscope Cameras are available with various weather proof, explosion proof and flame proof ratings.

VECTOR™ SYSTEM

The Vector™ System interface, via coaxial cable or fiber optic video transmission, allows the Process Microscope Camera to interface with the Cauty Vector™ System to perform one or more of the following:

- Two dimensional (2D) in-line particle analysis
- Surface roughness / defect detection
- Morphology CUT™ analysis

Various outputs can be provided by the Vector™, including 4-20 mA, TCP/IP, particle distribution data tables, on-line user interface graphs and data recording. A remote modem interface allows full plant access and remote technical support to view and analyze the images and data.

IN-LINE , REAL-TIME PARTICLE SIZING

Cauty systems provide an in-line, live video image of your process. Imagine how your process can benefit from a live video of your particles as they are growing. A Cauty Vector™ System can provide immediate feedback on particle size, distribution, aspect ratio, etc without sampling. Your data can be immediately analyzed for maximum product yield and control.

FIBER OPTIC LIGHTING

To perform the high speed imaging required for microscopic analysis, a great deal of illumination is required. This high-powered lighting is accomplished by the Cauty HYL80 fiber optic light. The Cauty light is a cold light, adding no additional heat to the process. This prevents bake-on of the product, as well as product degradation. The HYL80 allows viewing and image capturing (down to one micron) at speeds up to 1/100,000 second.

FUSED GLASS TECHNOLOGY

The Process Microscope Camera System provides high pressure and high temperature viewing inside of a reactor, due to the fused glass to metal seal. Many models carry pressure ratings through 6000 PSI and temperatures through 2000° F. This is a true high pressure, hermetic seal of glass and metal. The fused glass is not subject to leakage and has extraordinarily high impact resistance. Our fused glass technology allows for maintenance-free sealing!

FEATURES

- Fused Glass, High Pressure / Temperature Seal From Process
- CCD Based High-Speed Imaging Device
- NEMA 4, Explosion proof / Flameproof Ratings are Available
- Manual or Remote Zoom Control Options
- Microscopic Lens Option - One Micron Range
- Coaxial Cable, Fiber Optic Video Output Options

SPECIFICATIONS

Cameras:	Shutter speeds - selectable from 1/60 sec. to 1/100,000 sec.
Video:	NTSC (U.S) or PAL (Europe) - industry standard. Can be recorded on any VCR.
Power:	115V or 230V options, 50/60 Hz.
Ratings:	Weather proof - NEMA 4, IP 66 Explosion proof (U.S.) Class I, Div 1, Groups B,C&D, Flame proof (Europe) EEx d IIC T6 models are available.
Wetted Mat'l.	SS or Hastelloy

APPLICATIONS

- Crystallizers
- Fermentation Applications – Optical Density/Cell Count
- Mining-Floatation Cells and Thickener Tanks
- Web Inspection
- Fiber-Glass or Polymer Diameter

Dimensional Information

MZFL SERIES FLANGE MOUNTED CAMERAS

Mounting Connections:

- 3" & 4" 150# ANSI flange
- 80 mm & 100 mm DN PN16

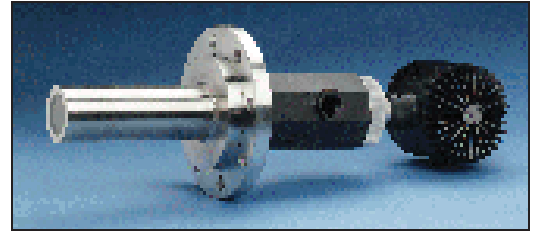
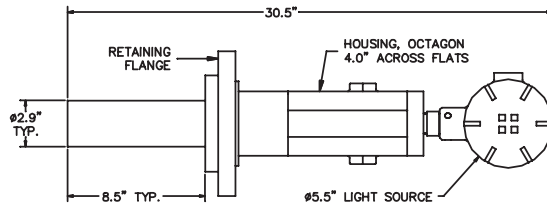

MZTRI SERIES TRI-CLAMP® CAMERAS

Mounting Connections:

- 4" Tri-Clamp® Mount

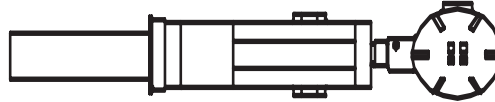

EPS 50 , EPS 12 SERIES FLANGE MOUNT WITH 90 ° ILLUMINATION

Mounting Connections:

- 4" & 6" 150# ANSI flange
- 100 mm & 150 mm DN PN16

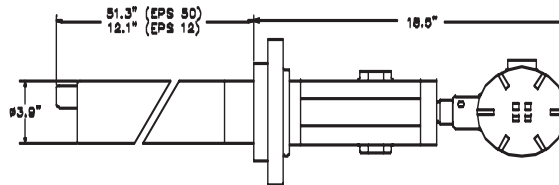

CPS 8B SERIES FLANGE MOUNT WITH 180 ° ILLUMINATION

Mounting Connections:

- 6" 150# 316LSS ANSI flange
- DSS Mount (sugar industry)
- 150 mm DN PN16

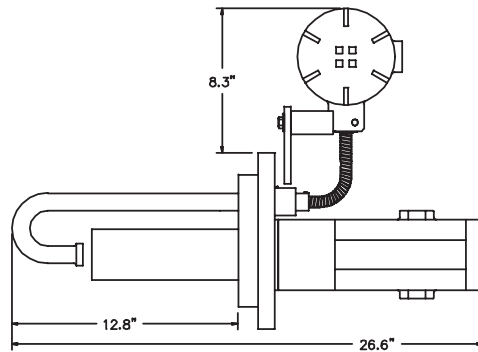

The digital photos shown below are actual images taken with a Process Microscope Camera.

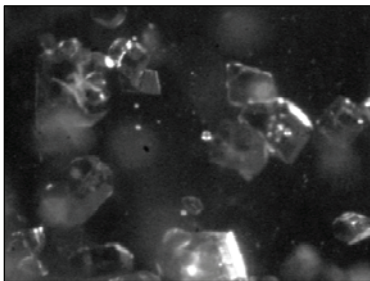

SUGAR CRYSTALS

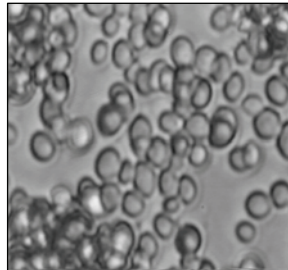

YEAST CELLS

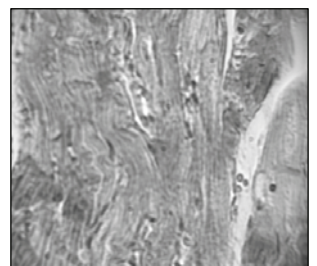

ANIMAL HEART TISSUE